

Centrifugal fan model TH Es.4

Single inlet fan, direct driven with an IEC-standard motor in form B3 which is mounted on a motorbase. The overhang impeller is mounted on the motor shaft and has an open blade impeller. The robust industrial fan is totally made of steel and painted in the agate grey color RAL 7038. The fan is suitable for the transport of granules and trimmings in nylon; for loading solid fuels into boilers, etc.

General data:

Drive	direct	
Motor position	horizontal	
Material casing/base	Steel	
Material impeller/hub	Steel	
Coating/protection	RAL 7038	
Operating temperature (max.)	15 (80)	°C
Medium density (altitude 0 m)	1,226	kg/m ³
Impeller speed	1.475	rpm
Weight	1.150	kg
Sound pressure level ±3 (at 1,5 m near the fan with inlet and outlet ducted, in free field)	87	dB(A)

Electric motor:

	225M	IEC
Power	45,0	kW
Motor speed	1.475	rpm
Electric supply	3x400V50Hz	V/Hz
Full load current	80,9	A
Enclosure	55	IP
Shape	B3T	
Efficiency class	IE3	

Curve TH 1002B @ 1475rpm @ 15°C @ 0m

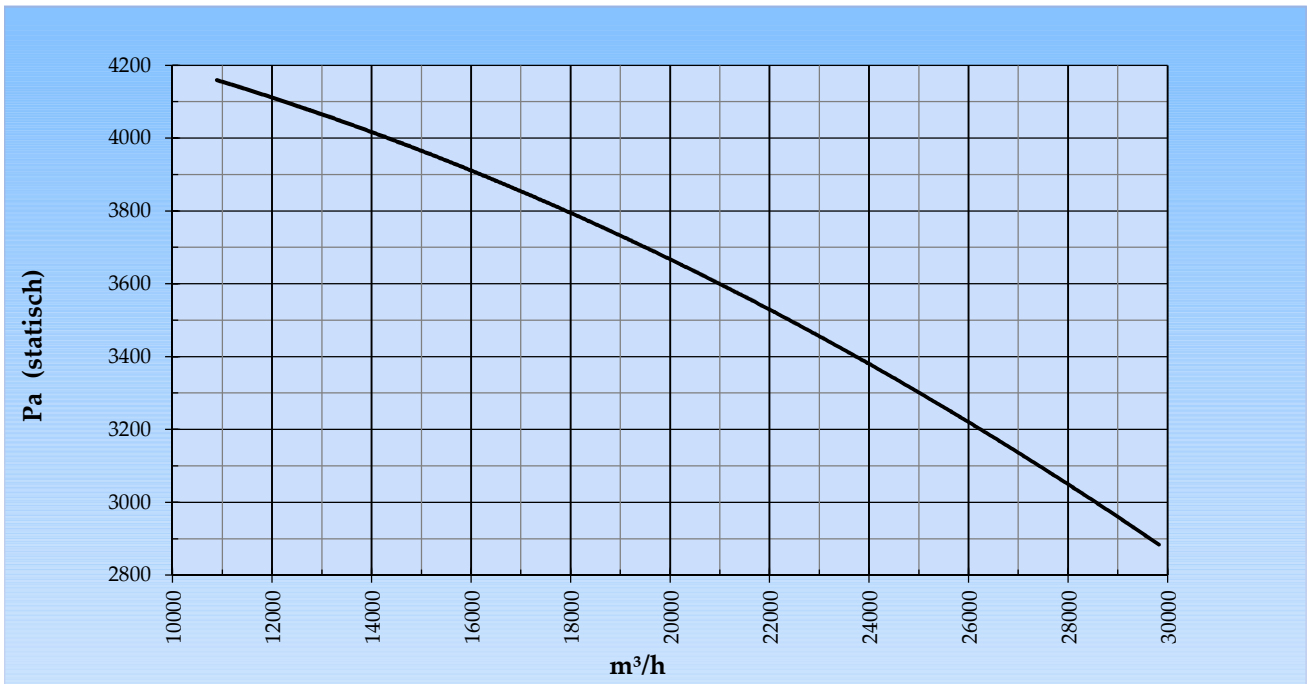

Possible discharge positions:

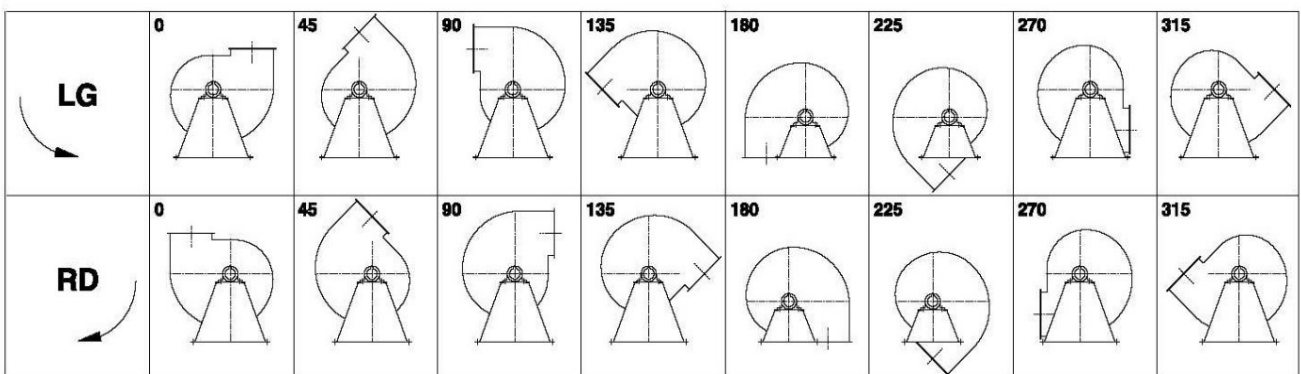

* (Pos 180 and 225 extra price)

Possible accessories

Mounting profiles for load distribution	--
Counterflange inlet/outlet	
Flexible connection inlet/outlet max. 80°C	zzØ 638 / pz 630x450
Anti-vibration mountings	6x 100x55/B/40° ShA
Inspectiondoor	
Drain	
Shaft seal without asbestos	
Coolingwheel (medium max. 150°C)	(incl. coating RAL9006)
Flexible connection inlet/outlet max. 150°C	zzØ 638 / pz 630x450
ATEX version	Zone 1 / 2 / 21 / 22
ATEX motor	Ex nA / Exe / Ex de
Coating suitable for outdoor application	RAL 5010 / RAL
Stainless steel version	304 / 316 / ...
Acoustic enclosure	