



Circular duct fan.

The RVK sileo series is designed for installation in ducts. The casing is manufactured from Polypropylene with 30% fibreglass reinforced plastic which creates a airtight casing.

Duct connected humid applications of the fan are possible due to the air tight casing and the IP 44 rated terminal box. The fans have efficient backward-curved blades and external rotor motors.

The VBM mounting clamp facilitates easy installation and removal, and prevents the transfer of vibration to the duct. Mounting kit for mounting on the wall or ceiling is available as option

The fans can be speed-controlled via a stepless thyristor or a 5-step transformer speed controller.

General data:

Max. Air flow	796	m3/h
Impeller speed	2.495	rpm
Input power	104	W
Voltage	1x230/50	V/Hz
Input current	0,46	A
Enclosure class, motor	44	IP
Weight	3,3	kg
Max. medium temp.	70	°C
Sound pressure level at 3M freefield	32,5	dB(A)

Options:

Flexible connection	VBM-200
Gravity Louvre shutter	RSK-200
Protection guard	RSG-200
Filter cassette	FRG-200
Silencer	GLD-A 200
MTV	MTY 0,5
MTP	STR-1-10L10

Curve:

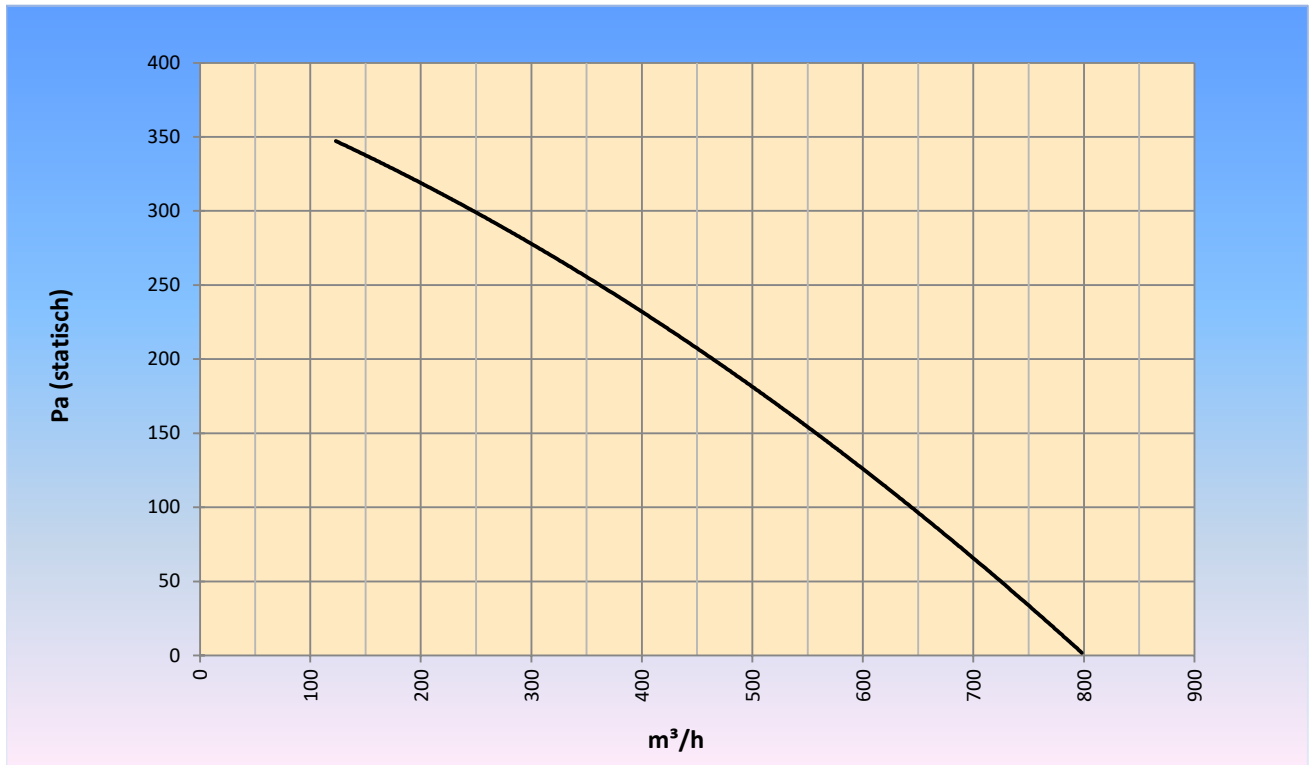

Dimensions:

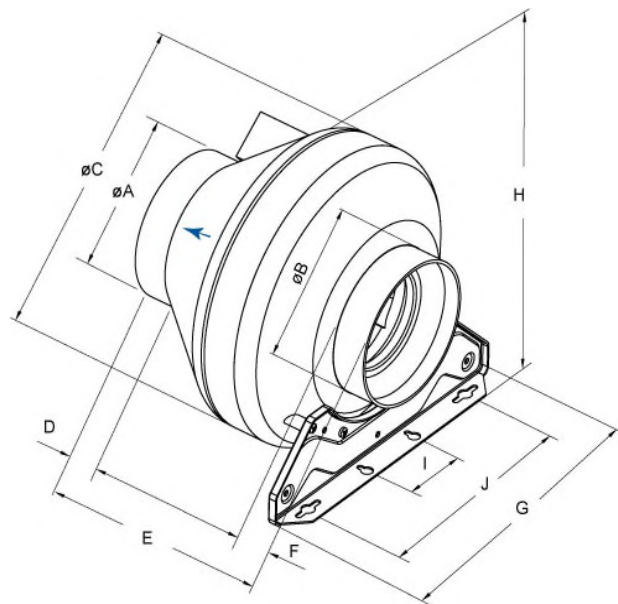

$\varnothing A$	$\varnothing B$	$\varnothing C$	D	E	F	G	H	I	J
199	199	341	30	229	30	272	360	60	200